

Technical Data **G3**

Base machine

Specifications, speed, acceleration

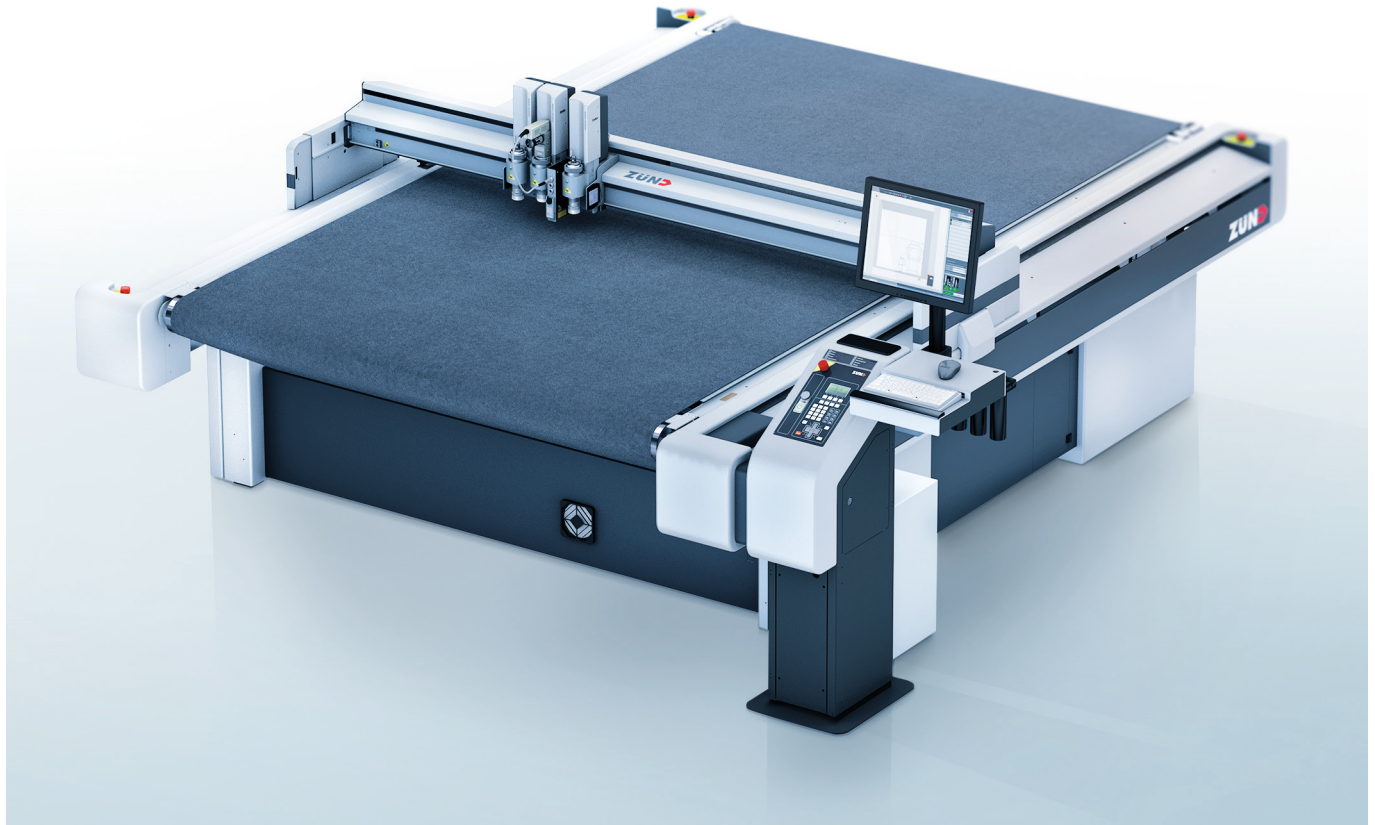

ZST-09-2016-m&k

Specifications

repeatability ¹⁾	± 0,03 mm / ± 0.001"
position accuracy ¹⁾	± 0,1 mm/m / ± 0.0012"/ft + repeatability
floor load requirements	200 kg/m ² / 45 lbs/ft ²
interface	RS232C/V24, Ethernet 10/100Mbit
operating temperature	10-35 °C / 50-95 °F
relative humidity	10-80 % non condensing
noise emission	< 75 dB (depending on material/cutting technology)
beam height ³⁾	30/60/120 mm / 1.1/2.3/4.7"
electrical requirements	AC 3ph+N+GND, 208/400 V, 50/60 Hz, 32 A
max. material weight	30 kg/m ² / 6 lbs/ft ² (manual loading) (can affect the evenness of the working surface)

Speed, acceleration ²⁾

max. speed X/Y-axis	1414 mm/s / 55"/s
max. acceleration X/Y-axis	9,3 m/s ² / 366"/s ²
max. speed Z-axis	500 mm/s / 20"/s
max. acceleration Z-axis	10 m/s ² / 393"/s ²
max. rotation speed T-axis	44.2 rad/s
max. rotation acceleration T-axis	3068 rad/s ²

1) X/Y drive system, static, at constant operating temperature (may vary depending on cutting tool/method).

2) Depending on cutter size, modules.

3) 120 mm / 4,7" beam height available only for cutter sizes L-3200, XL-3200.

Technical Data **G3**

Base machine

Dimensions, weight, material

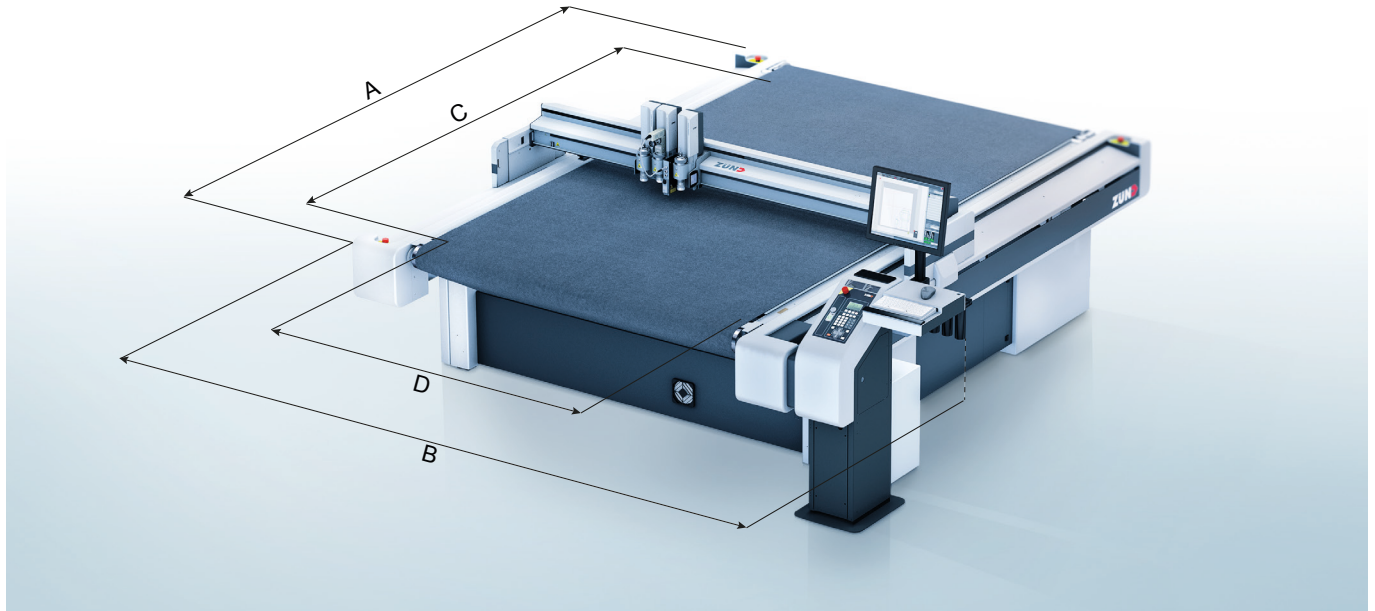

Type	Working area (D x C)	Overall dimensions, incl. workstation (B x A)	Machine weight
M-1600	1330 mm x 1600 mm / 52" x 63"	2360 mm x 2510 mm / 92" x 98"	670 kg / 1480 lbs
M-2500	1330 mm x 2500 mm / 52" x 98"	2360 mm x 3410 mm / 92" x 134"	840 kg / 1855 lbs
L-2500	1800 mm x 2500 mm / 70" x 98"	2830 mm x 3410 mm / 111" x 134"	970 kg / 2140 lbs
L-3200	1800 mm x 3200 mm / 70" x 125"	2830 mm x 4110 mm / 111" x 161"	1110 kg / 2450 lbs
XL-1600	2270 mm x 1600 mm / 89" x 63"	3300 mm x 2510 mm / 129" x 98"	890 kg / 1965 lbs
XL-3200	2270 mm x 3200 mm / 89" x 125"	3300 mm x 4110 mm / 129" x 161"	1280 kg / 2825 lbs
2XL-1600	2740 mm x 1600 mm / 107" x 63"	3770 mm x 2510 mm / 129" x 161"	980 kg / 2160 lbs
2XL-3200	2740 mm x 3200 mm / 107" x 125"	3770 mm x 4110 mm / 148" x 161"	1420 kg / 3130 lbs
3XL-1600	3210 mm x 1600 mm / 126" x 63"	4240 mm x 2510 mm / 166" x 98"	1120 kg / 2470 lbs
3XL-2500	3210 mm x 2500 mm / 126" x 98"	4240 mm x 3410 mm / 166" x 134"	1430 kg / 3155 lbs
3XL-3200	3210 mm x 3200 mm / 126" x 125"	4240 mm x 4110 mm / 166" x 161"	1610 kg / 3550 lbs

Type	max. materialwidth cutter with static work surface	max. materialwidth cutter with material transport
M-series	1610 mm / 63"	1330 mm / 52"
L-series	2080 mm / 81"	1800 mm / 70"
XL-series	2550 mm / 100"	2270 mm / 89"
2XL-series	3020 mm / 118"	2740 mm / 107"
3XL-series	3490 mm / 137"	3210 mm / 126"

Technical Data **G3**

Cutter with light curtain and static work surface

Dimensions, material

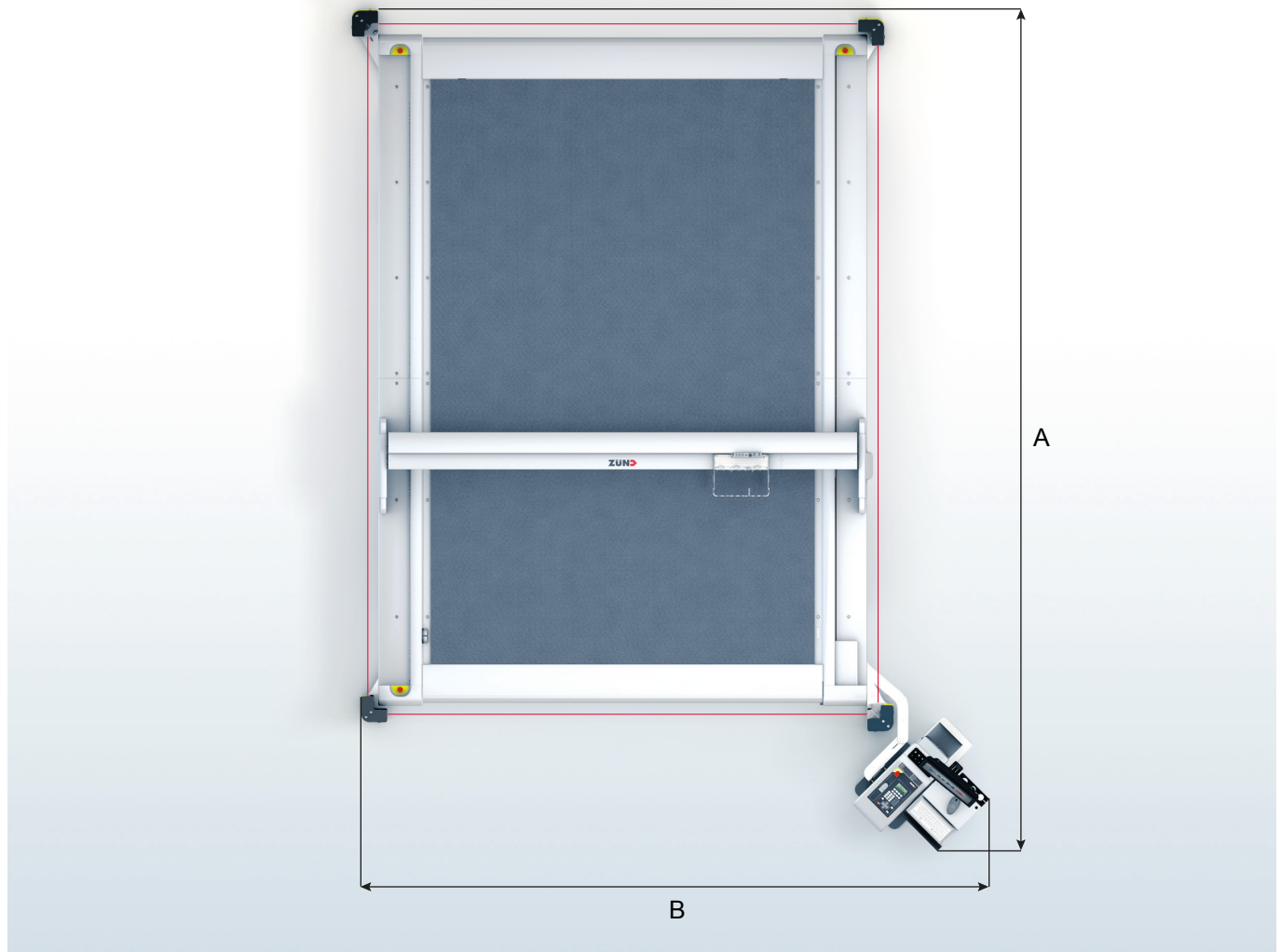

Type	Overall dimensions, incl. workstation (B x A)
M-1600	2980 mm × 3645 mm / 117" × 144"
M-2500	2980 mm × 4545 mm / 117" × 179"
L-2500	3450 mm × 4545 mm / 136" × 179"
L-3200	3450 mm × 5250 mm / 136" × 206"
XL-1600	3920 mm × 3645 mm / 154" × 144"
XL-3200	3920 mm × 5250 mm / 154" × 206"
2XL-1600	4390 mm × 3645 mm / 173" × 144"
2XL-3200	4390 mm × 5245 mm / 173" × 206"
3XL-1600	4860 mm × 3645 mm / 191" × 144"
3XL-2500	4860 mm × 4545 mm / 191" × 179"
3XL-3200	4860 mm × 5245 mm / 191" × 206"

Technical Data **G3**

Cutter with light curtain and material transport

Dimensions, material

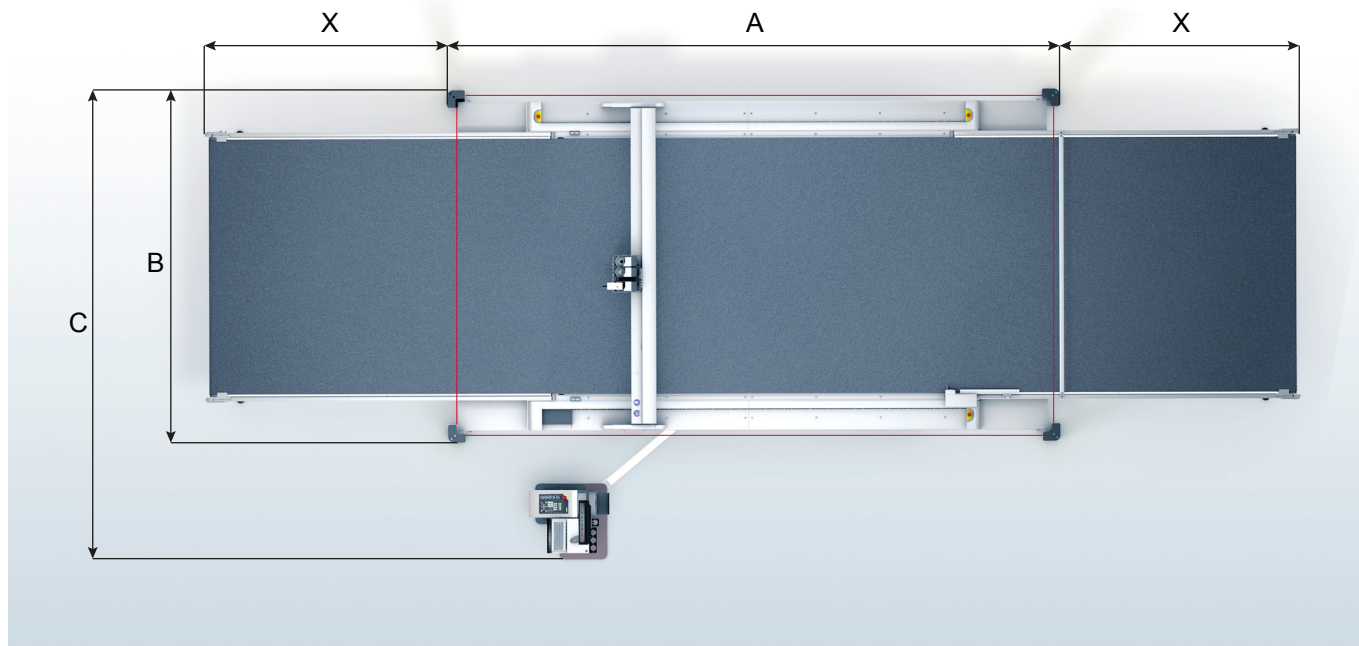

Type	Overall dimensions (A + 2X) × B	Overall dimensions incl. workstation (A + 2X) × C
M-1600	(3970 mm + 2X) × 2270 mm (156" + 2X) × 89"	(3970 mm + 2X) × 3280 mm (156" + 2X) × 129"
M-2500	(4870 mm + 2X) × 2270 mm (192" + 2X) × 89"	(4870 mm + 2X) × 3280 mm (192" + 2X) × 129"
L-2500	(4870 mm + 2X) × 2740 mm (192" + 2X) × 108"	(4870 mm + 2X) × 3750 mm (192" + 2X) × 148"
L-3200	(5570 mm + 2X) × 2740 mm (219" + 2X) × 108"	(5570 mm + 2X) × 3750 mm (219" + 2X) × 148"
XL-1600	(3970 mm + 2X) × 3210 mm (156" + 2X) × 126"	(3970 mm + 2X) × 4220 mm (156" + 2X) × 166"
XL-3200	(5570 mm + 2X) × 3210 mm (219" + 2X) × 126"	(5570 mm + 2X) × 4220 mm (219" + 2X) × 166"
2XL-1600	(3970 mm + 2X) × 3680 mm (156" + 2X) × 145"	(3970 mm + 2X) × 4690 mm (156" + 2X) × 185"
2XL-3200	(5570 mm + 2X) × 3680 mm (219" + 2X) × 145"	(5570 mm + 2X) × 4690 mm (219" + 2X) × 185"
3XL-1600	(3970 mm + 2X) × 4150 mm (156" + 2X) × 163"	(3970 mm + 2X) × 5160 mm (156" + 2X) × 203"
3XL-2500	(4870 mm + 2X) × 4150 mm (192" + 2X) × 163"	(4870 mm + 2X) × 5160 mm (192" + 2X) × 203"
3XL-3200	(5570 mm + 2X) × 4150 mm (219" + 2X) × 163"	(5570 mm + 2X) × 5160 mm (219" + 2X) × 203"

The length of X varies depending on the used cutter extension.
Technical data subject to change without notice.